

# This Box Contains These Parts:

**WARNING** For safety, remove all collars and leashes before allowing pet to enter any cage.

# extreme OUTBACK Log Cabin™



**A** 6mm x 55mm Bolt (8pcs)



**B** 6mm x 55mm Nut (8pcs)



**C** 3.5mm x 45mm Screw (4pcs)



**D** 3.5mm x 30mm Screw (8pcs)

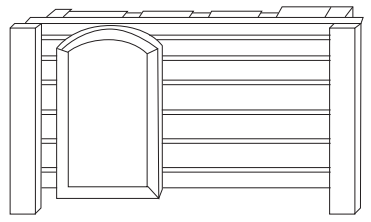

Front Panel

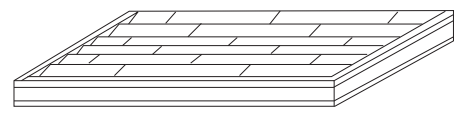

Roof Panel

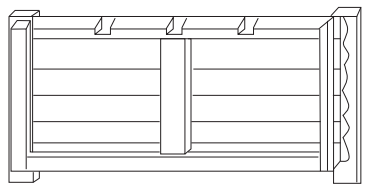

Back Panel

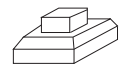

Legs x4

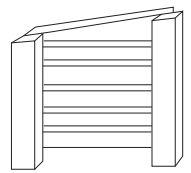

Side Panel x2

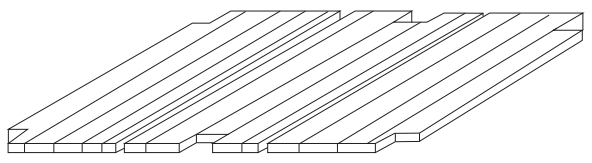

Floor Panel x3

**Assembly Instructions** \*Screwdriver Needed for Assembly

# Attach Front & Back Panels to Side Panels Required Components

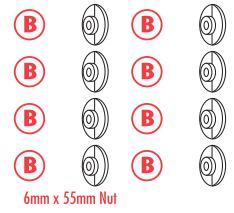

6mm x 55mm Nut

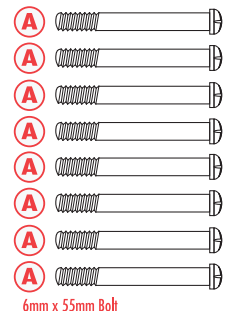

6mm x 55mm Bolt

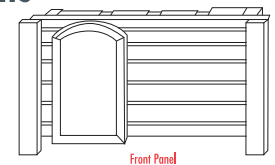

Front Panel

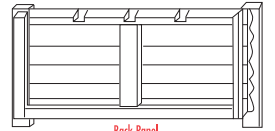

Back Panel

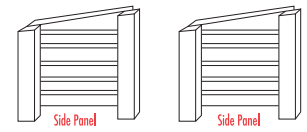

Side Panel

Side Panel

**STEP 1**

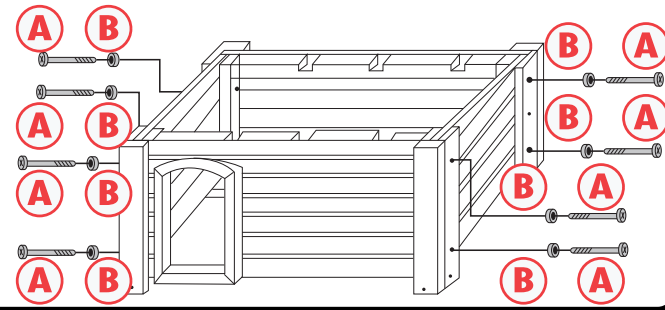

# Attach Feet Required Components

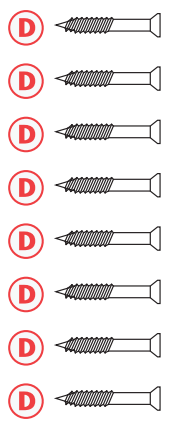

3.5mm x 30mm Screw

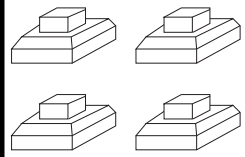

Legs

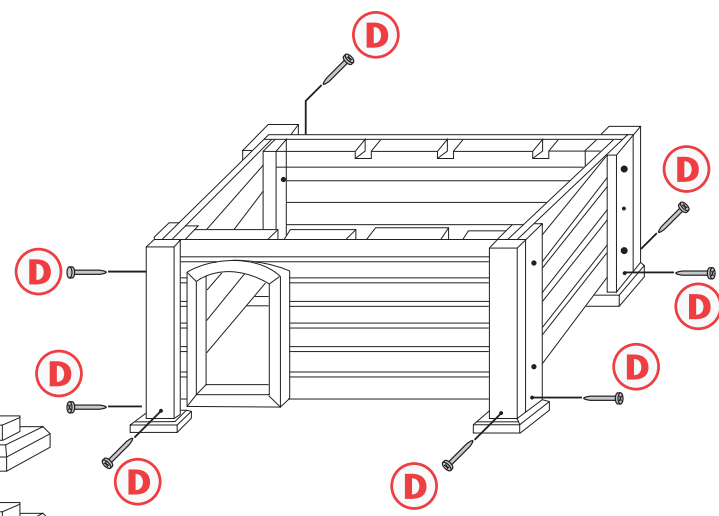

building instruction

## Drop in Floor Required Components

STEP 2

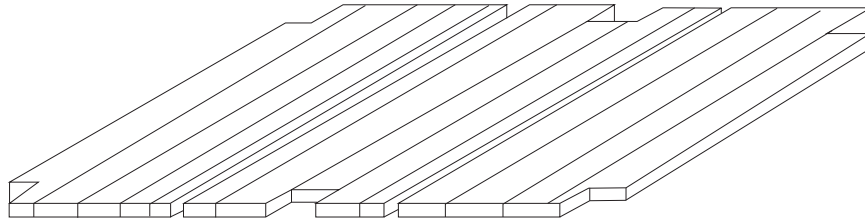

Floor Panel x3

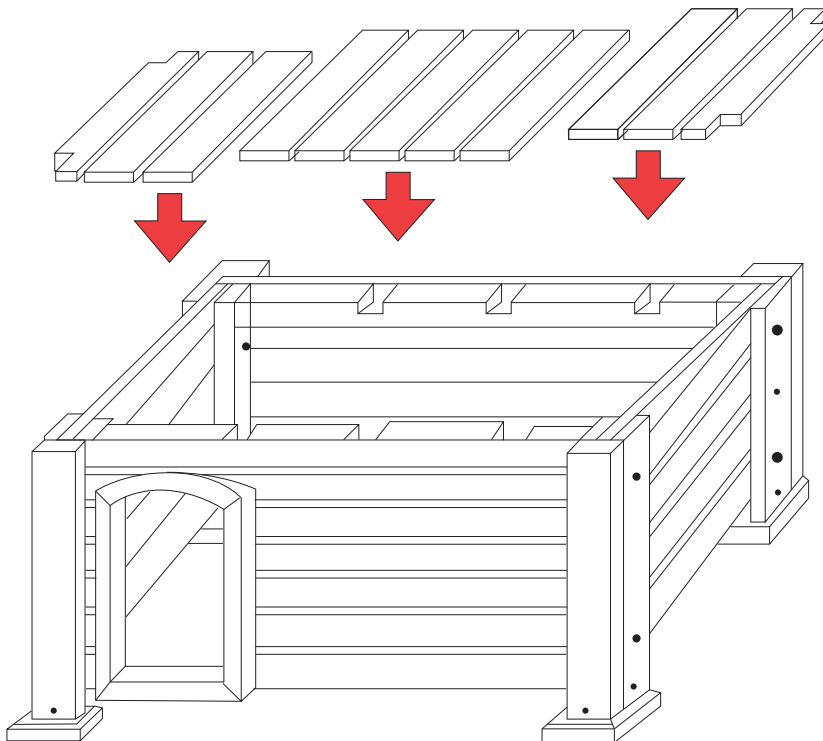

## Attach Roof Required Components

STEP 3

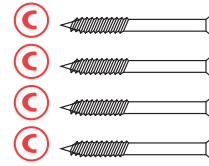

3.5mm x 45mm Screws

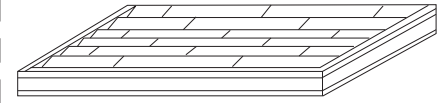

Roof Panel

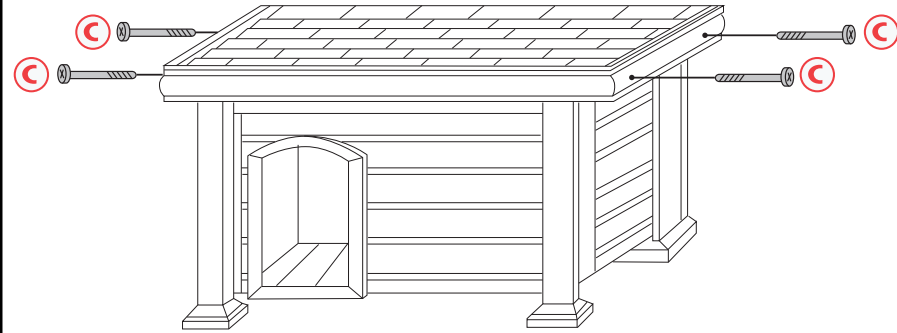

Floors may be removed through door after roof is attached.

## Completed Assembly

STEP 4

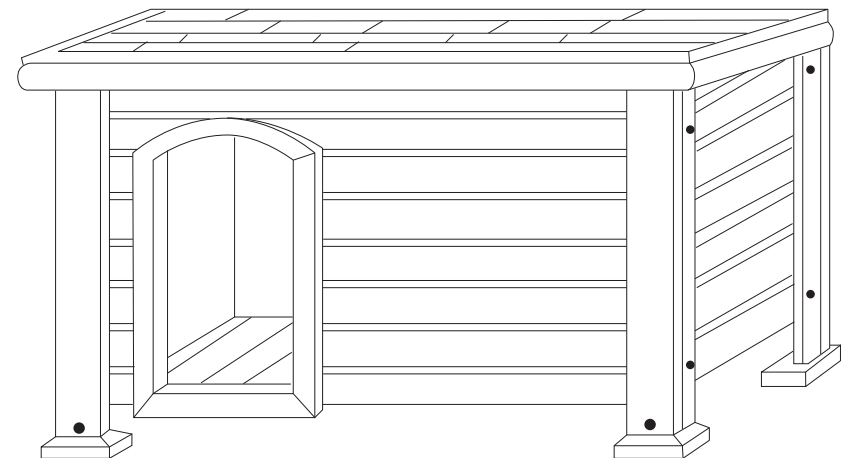

building  
instruction